

ASSEMBLY AND INSTALLATION INSTRUCTIONS

T0422

WARNING: TO AVOID RISK OF ELECTRICAL SHOCK, BE SURE TO SHUT OFF POWER BEFORE INSTALLING OR SERVICING THIS FIXTURE.

NOTE: 1. Before installing, consult local electrical codes for wiring and grounding requirements.
2. READ AND SAVE THESE INSTRUCTIONS.

Warning: LED electronics can be damaged by electro static discharge (ESD) shock. Before installation, discharge yourself by touching a grounded bare metal surface to remove this hazard. To avoid damage, do not touch the LED module.

Hardware Package (included):

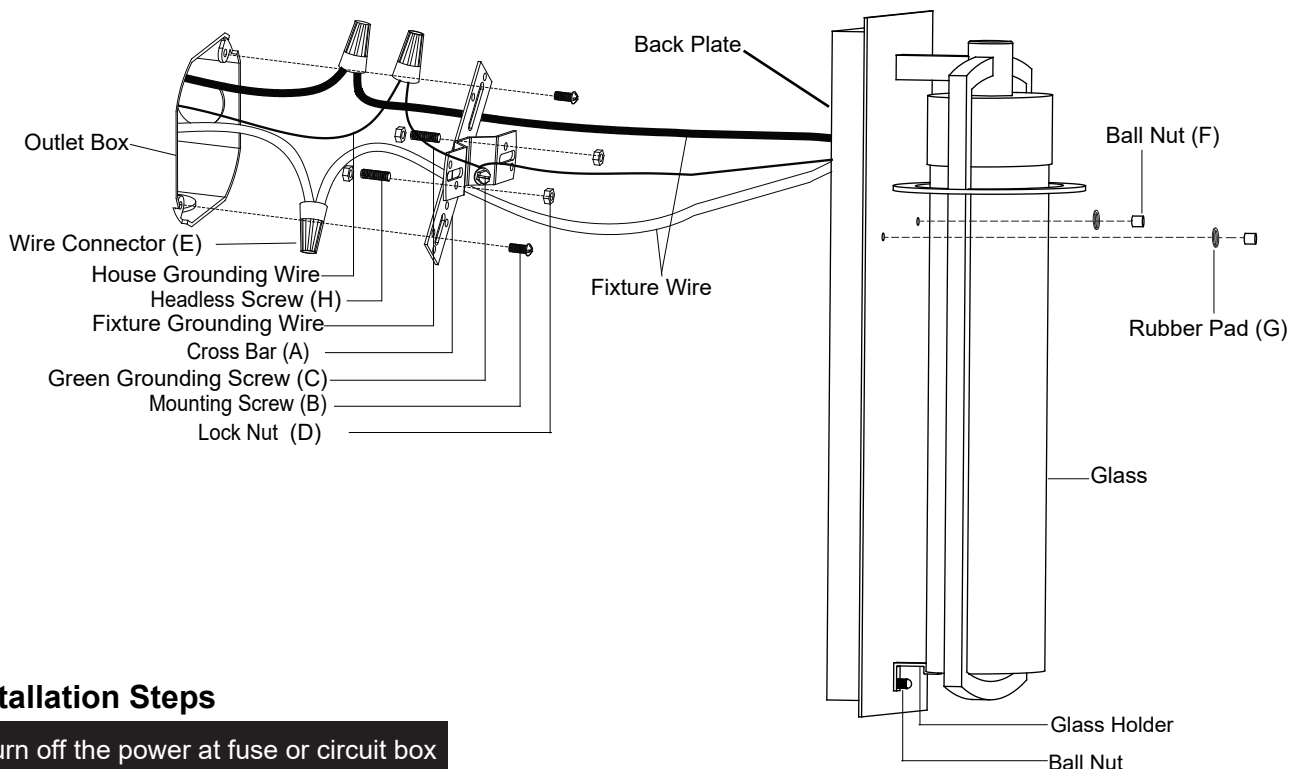
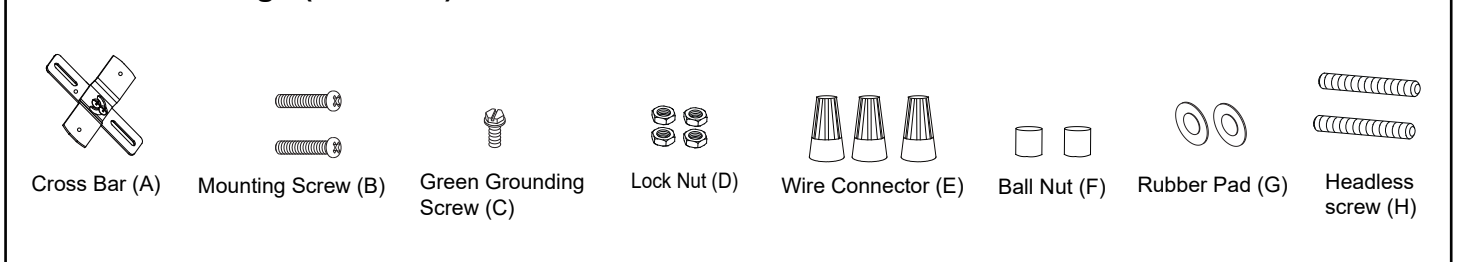

Installation Steps

Turn off the power at fuse or circuit box







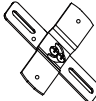

1. Thread two headless screws (H) through the cross bar (A), then secure them with four lock nuts (D) (two on each side of the cross bar (A)). Adjust the length of the headless screws (H) if necessary.
Note: Make sure that the headless screws (H) are lined up horizontally, to ensure that the fixture will be level.
2. Attach the cross bar (A) to the outlet box by using two mounting screws (B).

4. Pull out the outlet wires and house grounding wire from the outlet box. Make wire connections (E) using the wire connectors (E):
 - Connect the black wire from the fixture to the black wire from the power source.
 - Connect the white wire from the fixture to the white wire from the power source.
 - Attach the fixture grounding wire to the cross bar with the green grounding screw (C). Then connect it to the house grounding wire with a wire connector (E).
 Carefully put the wires back into the outlet box.
5. Attach the fixture to the cross bar (A) by inserting the headless screw (H), then secure it with two rubber pads (G) and two ball nuts (F).
6. Loosen glass holder use ball nut, after change the glass, secure the glass holder by ball nut again.

Turn on the power at fuse or circuit box.

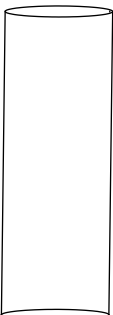
The following parts are available for re-order if damaged or missing.

Spare Parts List:

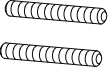
 Cross Bar (A)	 Mounting Screw (B)	 Green Grounding Screw (C)	 Lock Nut (D)	 Mounting Hardware 5899MM(1 SET) For T0422	 Glass 9945CS For T0422
 Wire Connector (E)	 Ball Nut (F)	 Rubber Pad (G)	 Headless Screw (H)		

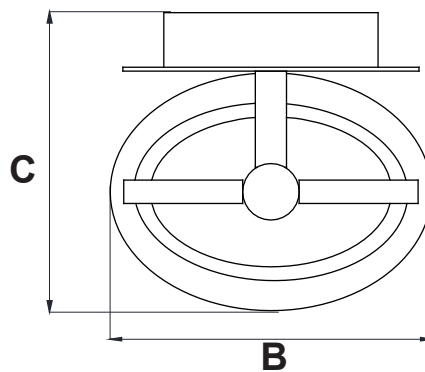
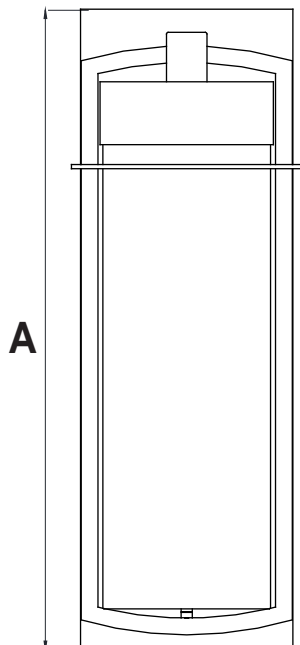

A: 15-1/2"
B: 5-1/2"
C: 5-1/4"