

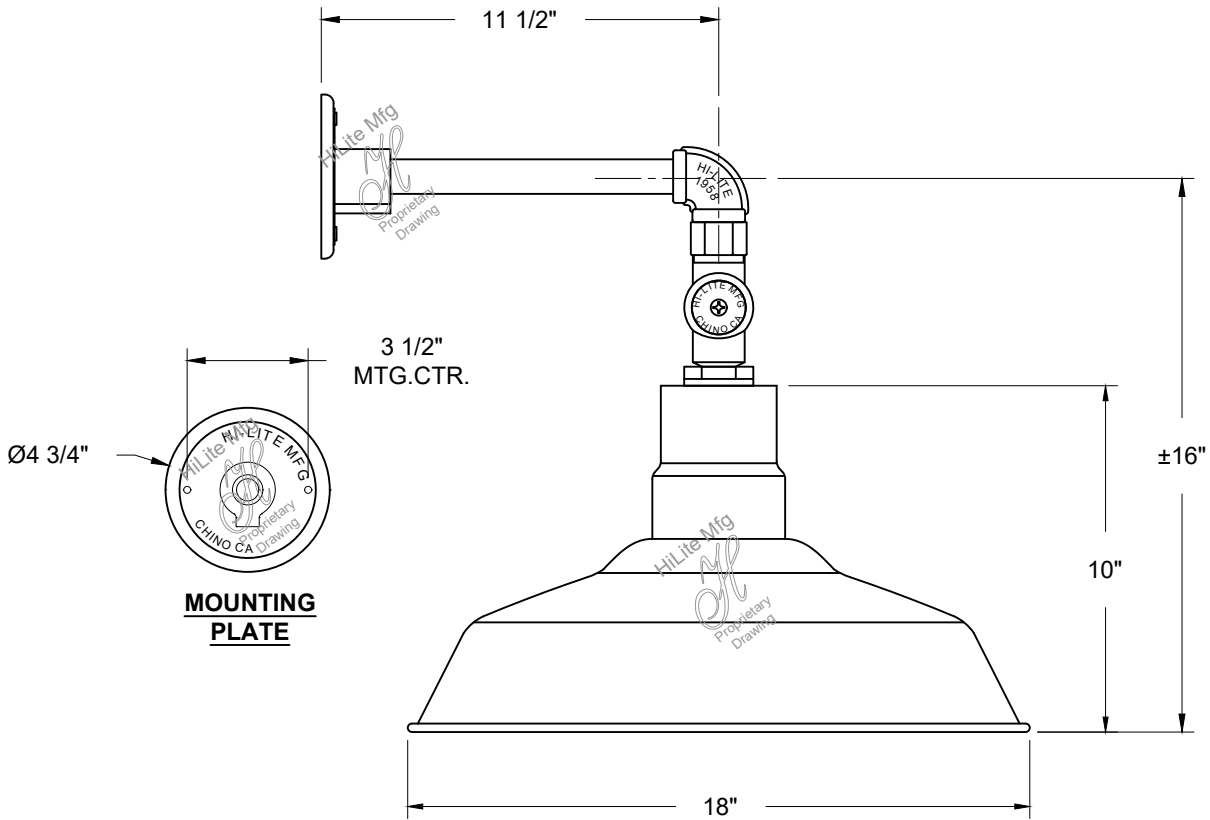

# HI-LITE MFG. CO., INC.

13450 Monte Vista Avenue  
 Chino, California 91710  
 Telephone: (909) 465-1999  
 Toll Free: (800) 465-0211  
 Fax: (909) 465-0907  
 www.hilitemfg.com

JOB NAME:		
SCALE:	DATE:	TYPE:
N.T.S.		
DRAWN BY:	QTY:	
S.M.		
SHEET:	REV:	



**WET LOCATION**

Item Number	Wattage	Voltage
H-QSN15118-SA/QSNB-44/QSNSK	200W	120V

**Finish**  
 91-Black, 93-White, 96-Galvanized,  
 145-Oil Rubbed Bronze

**Mounting**  
 Wall Mount

**Lamp/Socket**  
 1-Medium Base INC

\*\*\*Confidential and Proprietary. The information contained on this page is the sole property of Hi-Lite Mfg. Co., Inc. Any reproduction, redistribution, or use to profit from in part or as a whole without prior written authorization of Hi-Lite Mfg. Co., Inc. is unlawful, against trade laws and will be prosecuted to the fullest extent.